

Aluminium column SAL-9 Wł 1/2,5/3,2/5

diameter 176 mm at the base plate

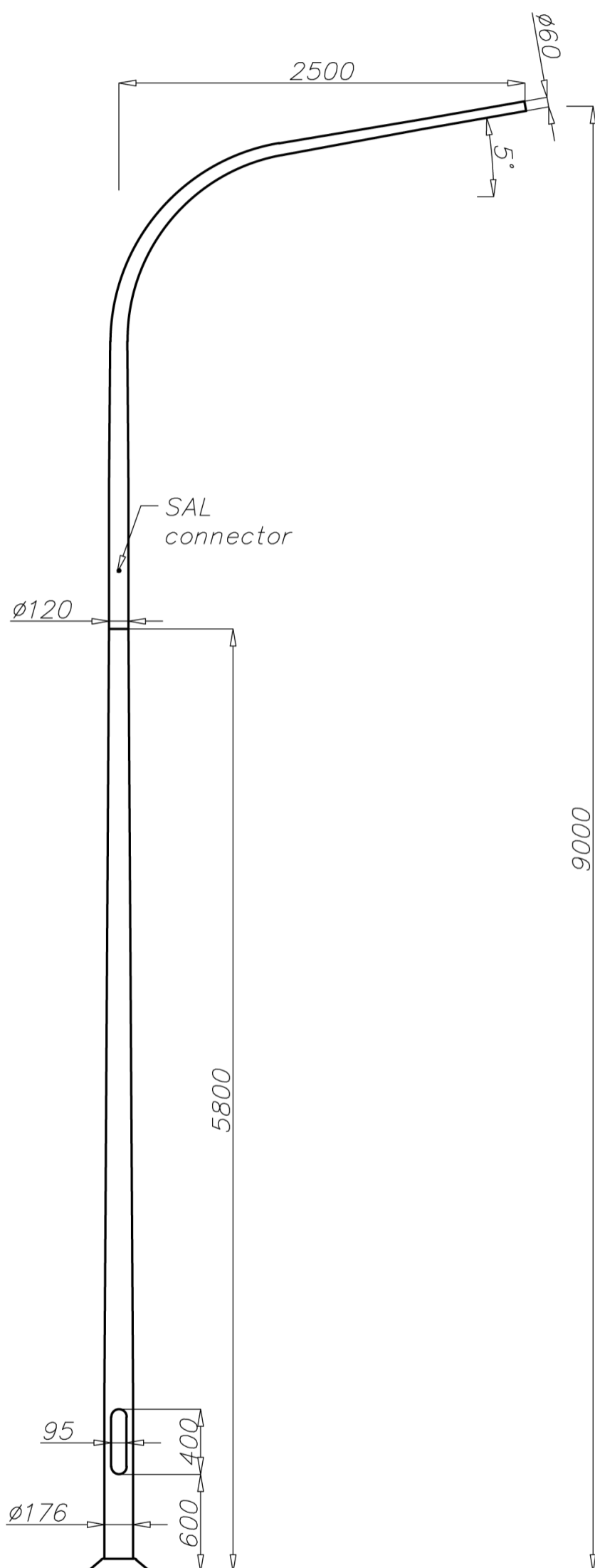

Technical data

Aluminium Column	SAL-9 Wł 1/2,5/3,2/5
Product code	42425
Column height H [m]	9
Height of lower section h1 + E [m]	5,8 + 0,35
Lower wall thickness [mm]	4,3
Height of upper section h2 [m]	3,2
Upper wall thickness [mm]	4
Net weight [kg]	53,9
Volume [m ³]	0,80
Post top column	luminaires with Ø60 spigot entry with weight and windage not exceeding data in resistance calculations
Concrete footing / reinforcement basket	B-70 / Z-70
Concrete footing code/reinforcement basket code	311170 / 311207
Hot galvanized nut set /Hot galvanized ripable nut set	4012 / 4013

Resistance calculations

SAL-9 Wł 1/2,5/3,2/5 code 42425	acceptable windage of single luminaire [m ²] for Cx=0,7			
	Vref. = 22 m/s	Vref. = 24 m/s	Vref. = 26 m/s	Vref. = 28 m/s
acceptable mass of luminaires [kg]	I zone, III location category	I and III zone, III location category to 450m AMSL	II zone, III location category	III zone, III location category to 755m AMSL
15	0,56	0,45	0,30	0,25

- surface: polished aluminium
- anodising in 10 colours, each with possibility of brightening
- option of powder painting in RAL colours (other colours available on request)
- elastomer protection in the color of the column to a height of 350 mm (other height on request)
- ROSA standard wiring chamber
- packing: sleeve material
- passive safety certificate 100NE2

