

Aluminium extension arm WR-2/3

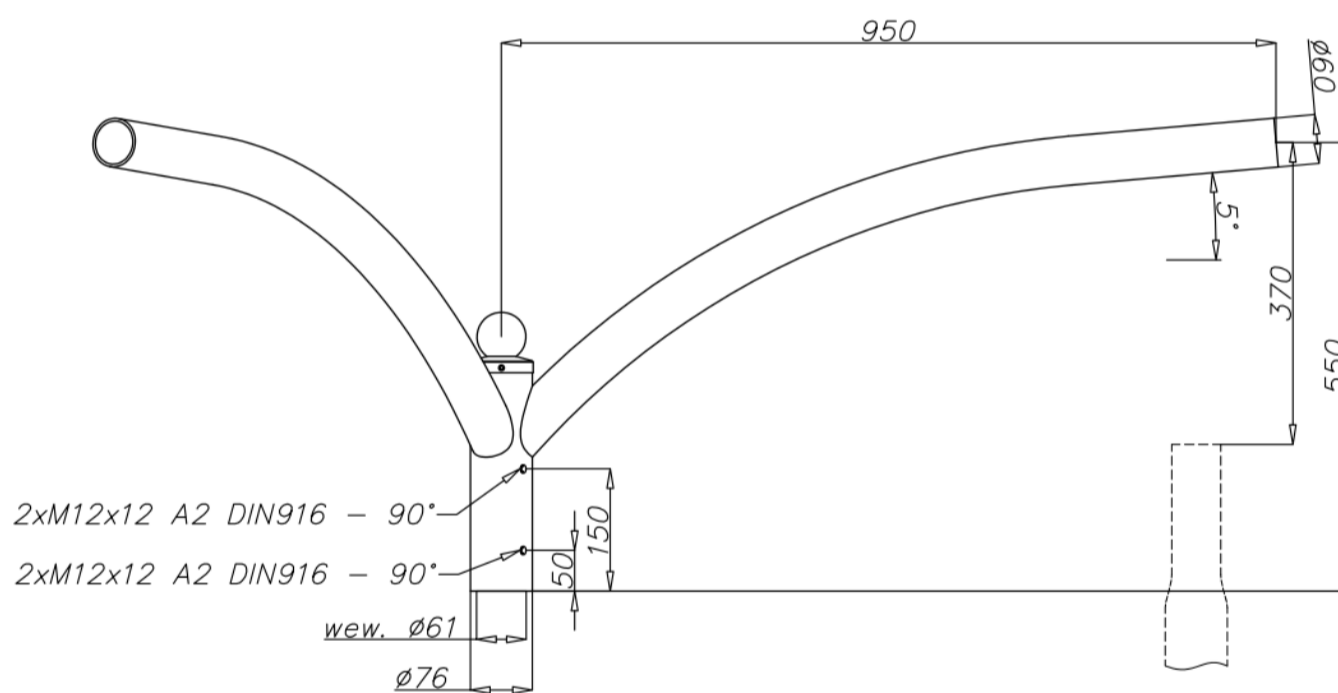

Technical data

Extension arm	WR-2/3
Product code	472023
Application	aluminium columns with ending $\phi 60 \times 180$
Arm quantity	3
Net weight [kg]	6,3
Windage [m ²]	0,145
Volume [m ³]	0,26
Assembling diameter of luminaire [mm]	$\phi 60 \times 100$
Compatible luminaires	street luminaires

- anodising in 10 colours, each with possibility of brightening
- option of powder painting in RAL colours (other colours available on request)
- packing: sleeve material
- CE certificate valid for use on poles manufactured by ROSA company