

# Aluminium extension arm WR-18/1/1,5/5

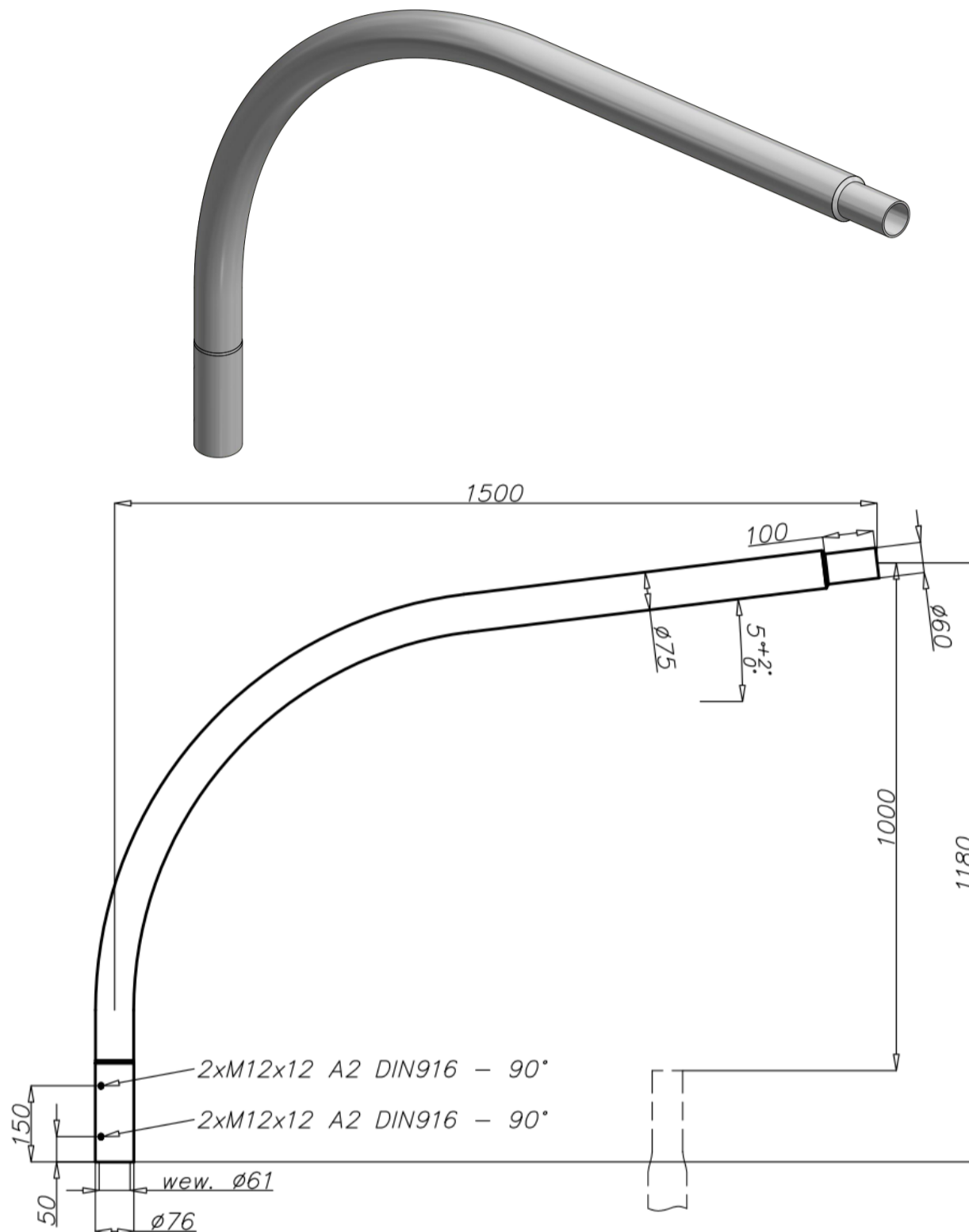

## Technical data

Extension arm	WR-18/1/1,5/5
Product code	47218115
Application	aluminium columns with ending $\varnothing 60 \times 180$
Arm quantity	1
Net weight [kg]	5,2
Windage [m <sup>2</sup> ]	0,17
Volume [m <sup>3</sup> ]	0,06
Assembling diameter of luminaire [mm]	$\varnothing 60 \times 100$
Compatible luminaires	street luminaires

- anodising in 10 colours, each with possibility of brightening
- option of powder painting in RAL colours (other colours available on request)
- packing: sleeve material
- CE certificate valid for use on poles manufactured by ROSA company